

Dallas Parks & Recreation Dept. Admin. Offices -- Rev 3 **Dallas, Texas**

Architect

Perkins + Will
10100 Central Expressway Suite 300
Dallas, TX 75231
Tel: 214-283-8700

Contractor

Denco Construction
5525 Lyons Rd
Garland, TX 75043
Tel: 214-869-9199

Plan Revision: **Hand Written Door Schedule -- Dated 6/18/2015, Dated: 7/1/2015**

Dallas Parks & Recreation Dept. Admin. Offices -- Rev 3
Dallas, Texas

Manufacturers & Finishes

Manufacturers

<None>
Curries
Glynn-Johnson
Ives
LCN
NGP
Schlage
Von Duprin

Finishes

605 - Bright brass, clear coated
606 - Satin brass, clear coated
640 - Oxidized satin bronze plated over
copper plate, oil rubbed
US10B - Dark oxidized satin bronze, oil rubbed
USP - Primed for painting

Index of Abbreviations

Anchor Type

WPS - Welded Pipe Spacer Anchor
WSC - Welded Steel Stud Anchor

Door Core

HC - Honeycomb
SS-22 - 22 ga. Steel Stiffeners

Door Finish

PRIME-GRAY - Gray Primer

Door Mat'l

A60 - A-60 Galvanneal Steel
CRS - Cold Rolled Steel

Door Seam

N - Seamless, Edge Filled

Door Series

707S - Commercial Grade
747S - Steel Stiffened

Door Type

F - Flush
FG - Full glass

FL - Bottom Louver, 12" x 12"

Frame Construction

FW - Full (Continuous) Weld
SW - Weld Seam

Frame Mat'l

A60 - A-60 Galvanneal Steel
CRS - Cold Rolled Steel

Frame Profile

M - Single Bend

Frame Series

CCW - Cut & Notch Frames
M - Masonry Flush Frames

Hand

LH - Left Hand
LHR - Left Hand Reverse
LHRA/RHRA - Both Hands Reverse Active
RH - Right Hand
RHR - Right Hand Reverse
RHRA - Right Hand Reverse Active

Label





WH-C - WH "C" - 45 min.







Lite Kit







TYPE 9 - 3/8" Pocket





note: all door hardware sets to be adjusted for hollow metal frames





Openings Schedule





Opening Number(s)	Elevation	Nominal Width	Nominal Height	Type	Hardware Group	Remarks	Hand	Location 1	To/ From	Location 2	Label	Frame Catalog	Frame Series	Frame Mat'l	Frame Gauge	Frame Profile	Jamb Depth	Facing (Jamb, Hd)	Anchor Type	Frame Construction	Door Catalog	Door Series	Door Mat'l	Door Gauge	Door Thickness	Door Type	Lite Kit	Door Core	Door Seam	Door Finish
101A						AL STORERONT BY OTHERS																								
101A						AL STORERONT BY OTHERS																								
105	 2-LH	36"	80"	Single	103A		LH	CORRIDOR 102A	TO	OFFICE 105		Curries	CCW	CRS	16	M	5 3/4"	2", 4"	WSC	SW	Curries	707S	CRS	18	1 3/4"	FG*	TYPE 9	HC	N	PRIME-GRAY
106	 2-LH	36"	80"	Single	103A		LH	CORRIDOR 102A	TO	OFFICE 106		Curries	CCW	CRS	16	M	5 3/4"	2", 4"	WSC	SW	Curries	707S	CRS	18	1 3/4"	FG*	TYPE 9	HC	N	PRIME-GRAY
107	E-1	36"	80"	Single	503		LH	CORRIDOR 114	TO	STORAGE 107		Curries	M	CRS	16	M	5 3/4"	2", 4"	WPS	SW	Curries	707S	CRS	18	1 3/4"	F		HC	N	PRIME-GRAY
108	 2-RH	36"	80"	Single	103A		RH	CORRIDOR 114	TO	OFFICE 108		Curries	CCW	CRS	16	M	5 3/4"	2", 4"	WPS	SW	Curries	707S	CRS	18	1 3/4"	FG*	TYPE 9	HC	N	PRIME-GRAY
109	 2-LH	36"	80"	Single	103A		LH	CORRIDOR 114	TO	OFFICE 109		Curries	CCW	CRS	16	M	5 3/4"	2", 4"	WPS	SW	Curries	707S	CRS	18	1 3/4"	FG*	TYPE 9	HC	N	PRIME-GRAY
110	 2-LH	36"	80"	Single	103A		LH	CORRIDOR 114	TO	OFFICE 110		Curries	CCW	CRS	16	M	5 3/4"	2", 4"	WPS	SW	Curries	707S	CRS	18	1 3/4"	FG*	TYPE 9	HC	N	PRIME-GRAY







Opening Number(s)	Elevation	Nominal Width	Nominal Height	Type	Hardware Group	Remarks	Hand	Location 1	To/ From	Location 2	Label	Frame Catalog	Frame Series	Frame Mat'l	Frame Gauge	Frame Profile	Jamb Depth	Facing (Jamb, Hd)	Anchor Type	Frame Construction	Door Catalog	Door Series	Door Mat'l	Door Gauge	Door Thickness	Door Type	Door Lite Kit	Door Core	Door Seam	Door Finish	
103B	 2-LHR-ADD	36"	80"	Single	103A	ADDED OPENING	LHR	CORRIDOR 102A	TO	OFFICE 103		Curries	CCW	CRS	16	M	5 3/4"	2", 4"	WPS	SW	Curries	707S	CRS	18	1 3/4"	FG*	TYPE 9	HC	N	PRIME-GRAY	
111	 2-LH	36"	80"	Single	103A		LH	CORRIDOR 114	TO	OFFICE 111		Curries	CCW	CRS	16	M	5 3/4"	2", 4"	WPS	SW	Curries	707S	CRS	18	1 3/4"	FG*	TYPE 9	HC	N	PRIME-GRAY	
112	 2-LH	36"	80"	Single	103A		LH	ADMIN SPEC 116	TO	OFFICE 112		Curries	CCW	CRS	16	M	5 3/4"	2", 4"	WSC	SW	Curries	707S	CRS	18	1 3/4"	FG*	TYPE 9	HC	N	PRIME-GRAY	
112A	 2-RH	36"	80"	Single	103A		RH	ADMIN SPEC 116	TO	OFFICE 112A		Curries	CCW	CRS	16	M	5 3/4"	2", 4"	WSC	SW	Curries	707S	CRS	18	1 3/4"	FG*	TYPE 9	HC	N	PRIME-GRAY	
113	E-1	36"	80"	Single	207		LH	CORRIDOR 114	TO	MECH 113		Curries	M	CRS	16	M	5 3/4"	2", 4"	WPS	SW	Curries	707S	CRS	18	1 3/4"	F		HC	N	PRIME-GRAY	
114		36", 36"	80"	Pair	714A.1	AL STOREFRONT BY OTHERS	RH/R																								
115	E-2	36"	80"	Single	201		RH	CORRIDOR 114	TO	STORAGE 115		Curries	M	CRS	16	M	5 3/4"	2", 4"	WPS	SW	Curries	707S	CRS	18	1 3/4"	F		HC	N	PRIME-GRAY	
116A	 2-LH	36"	80"	Single	507A		LH	CORRIDOR 114	TO	ADMIN SPEC 116		Curries	CCW	CRS	16	M	5 3/4"	2", 4"	WPS	SW	Curries	707S	CRS	18	1 3/4"	FG*	TYPE 9	HC	N	PRIME-GRAY	
116B	E-3	36"	80"	Single	103A		LHR	ADMIN SPEC 116	FROM	OFFICE 110		Curries	M	CRS	16	M	5 3/4"	2", 4"	WSC	SW	Curries	707S	CRS	18	1 3/4"	FG*	TYPE 9	HC	N	PRIME-GRAY	
117	E-2	36"	80"	Single	103A		RH	OFFICE 119	TO	OFFICE 117		Curries	M	CRS	16	M	5 3/4"	2", 4"	WPS	SW	Curries	707S	CRS	18	1 3/4"	FG*	TYPE 9	HC	N	PRIME-GRAY	
117A	 2-RH	36"	80"	Single	103A		RH	CORRIDOR 114	TO	OFFICE 117		Curries	CCW	CRS	16	M	5 3/4"	2", 4"	WPS	SW	Curries	707S	CRS	18	1 3/4"	FG*	TYPE 9	HC	N	PRIME-GRAY	

Opening Number(s)	Elevation	Nominal Width	Nominal Height	Type	Hardware Group	Remarks	Hand	Location 1	To/ From	Location 2	Label	Frame Catalog	Frame Series	Frame Mat'l	Frame Gauge	Frame Profile	Jamb Depth	Facing (Jamb, Hd)	Anchor Type	Frame Construction	Door Catalog	Door Series	Door Mat'l	Door Gauge	Door Thickness	Door Type	Door Lite Kit	Door Core	Door Seam	Door Finish	
118A	E-2	36"	80"	Single	503A		RH	ADMIN SPEC 116	TO	OFFICE 118		Curries	M	CRS	16	M	5 3/4"	2", 4"	WSC	SW	Curries	707S	CRS	18	1 3/4"	FG*	TYPE 9	HC	N	PRIME-GRAY	
118B	 2-RH	36"	80"	Single	507A		RH	CORRIDOR 114	TO	OFFICE 118		Curries	CCW	CRS	16	M	5 3/4"	2", 4"	WPS	SW	Curries	707S	CRS	18	1 3/4"	FG*	TYPE 9	HC	N	PRIME-GRAY	
119	 2-RH	36"	80"	Single	503A		RH	CORRIDOR 114	TO	OFFICE 119		Curries	CCW	CRS	16	M	5 3/4"	2", 4"	WPS	SW	Curries	707S	CRS	18	1 3/4"	FG*	TYPE 9	HC	N	PRIME-GRAY	
120	E-1	36"	80"	Single	503		LH	RECEPTION 121	TO	OFFICE 120		Curries	M	CRS	16	M	5 3/4"	2", 4"	WSC	SW	Curries	707S	CRS	18	1 3/4"	F		HC	N	PRIME-GRAY	
121-BL	 121-CASED-OPEN BL											Curries	CCW	CRS	16	M	5 3/4"	2", 4"	WPS	SW											
122	 2-RH	36"	80"	Single	507A		RH	CORRIDOR 122A	TO	RECEPTION 121		Curries	CCW	CRS	16	M	5 3/4"	2", 4"	WPS	SW	Curries	707S	CRS	18	1 3/4"	FG*	TYPE 9	HC	N	PRIME-GRAY	
123	E-2	36"	80"	Single	201W		RH	CORRIDOR 122A	TO	MACHINE 123		Curries	M	CRS	16	M	5 3/4"	2", 4"	WPS	SW	Curries	707S	CRS	18	1 3/4"	F		HC	N	PRIME-GRAY	
124	 2-LH	36"	80"	Single	507A		LH	CORRIDOR 122A	TO	OFFICE 124		Curries	CCW	CRS	16	M	5 3/4"	2", 4"	WPS	SW	Curries	707S	CRS	18	1 3/4"	FG*	TYPE 9	HC	N	PRIME-GRAY	
125	E-2	36"	80"	Single	207		RH	CORRIDOR 122A	TO	DATA CENTER 125		Curries	M	CRS	16	M	5 3/4"	2", 4"	WPS	SW	Curries	707S	CRS	18	1 3/4"	F		HC	N	PRIME-GRAY	
126	 2-RH	36"	80"	Single	103A		RH	SERVICES 122	TO	FIELD COORD 126		Curries	CCW	CRS	16	M	5 3/4"	2", 4"	WSC	SW	Curries	707S	CRS	18	1 3/4"	FG*	TYPE 9	HC	N	PRIME-GRAY	
126A	E-2	36"	80"	Single	103A		RH	SERVICES 122	TO	STAFF OFC 126A		Curries	M	CRS	16	M	5 3/4"	2", 4"	WSC	SW	Curries	707S	CRS	18	1 3/4"	FG*	TYPE 9	HC	N	PRIME-GRAY	

Opening Number(s)	Elevation	Nominal Width	Nominal Height	Type	Hardware Group	Remarks	Hand	Location 1	To/ From	Location 2	Label	Frame Catalog	Frame Series	Frame Mat'l	Frame Gauge	Frame Profile	Jamb Depth	Facing (Jamb, Hd)	Anchor Type	Frame Construction	Door Catalog	Door Series	Door Mat'l	Door Gauge	Door Thickness	Door Type	Lite Kit	Door Core	Door Seam	Door Finish
126B	E-2	36"	80"	Single	501A		RH	SERVICES 122	TO	STORAGE 126B		Curries	M	CRS	16	M	5 3/4"	2", 4"	WSC	SW	Curries	707S	CRS	18	1 3/4"	FG*	TYPE 9	HC	N	PRIME-GRAY
127	E-1	36"	80"	Single	201		LH	CORRIDOR 122A	TO	JANITOR 127		Curries	M	CRS	16	M	5 3/4"	2", 4"	WPS	SW	Curries	707S	CRS	18	1 3/4"	F		HC	N	PRIME-GRAY
128	E-2	36"	80"	Single	103A		RH	MAINTENANCETO	TO	OFFICE 128		Curries	M	CRS	16	M	5 3/4"	2", 4"	WSC	SW	Curries	707S	CRS	18	1 3/4"	FG*	TYPE 9	HC	N	PRIME-GRAY
129	E-4	36"	80"	Single	731R	45 min rating	RHR	CORRIDOR 138A	FROM	STAIR 129	WH-C	Curries	M	CRS	16	M	5 3/4"	2", 4"	WPS	SW	Curries	707S	CRS	18	1 3/4"	F		HC	N	PRIME-GRAY
130	 2-RH	36"	80"	Single	103A		RH	MAINTENANCETO	TO	OFFICE 130		Curries	CCW	CRS	16	M	5 3/4"	2", 4"	WSC	SW	Curries	707S	CRS	18	1 3/4"	FG*	TYPE 9	HC	N	PRIME-GRAY
131A	E-1	36"	80"	Single	207		LH	CORRIDOR 138A	TO	MECH 131		Curries	M	CRS	16	M	5 3/4"	2", 4"	WPS	SW	Curries	707S	CRS	18	1 3/4"	F		HC	N	PRIME-GRAY
131B		30", 30"	80"	Pair	204.LVR		RHRA	EXTERIOR	FROM	MECH 131				ETR	16		2", 4"				Curries	747S	A60	14	2"	FL*		SS-22	N	PRIME-GRAY
132	 2-LH	36"	80"	Single	103A		LH	MAINTENANCETO	TO	OFFICE 132		Curries	CCW	CRS	16	M	5 3/4"	2", 4"	WSC	SW	Curries	707S	CRS	18	1 3/4"	FG*	TYPE 9	HC	N	PRIME-GRAY
132A	 2-RH	36"	80"	Single	103A		RH	MAINTENANCETO	TO	OFFICE 132A		Curries	CCW	CRS	16	M	5 3/4"	2", 4"	WSC	SW	Curries	707S	CRS	18	1 3/4"	FG*	TYPE 9	HC	N	PRIME-GRAY
133	E-2	36"	80"	Single	207		RH	CORRIDOR 138A	TO	ELEC 133		Curries	M	CRS	16	M	5 3/4"	2", 4"	WPS	SW	Curries	707S	CRS	18	1 3/4"	F		HC	N	PRIME-GRAY
134	 2-LH	36"	80"	Single	501A		LH	CORRIDOR 138A	TO	MAINTENANCE 134		Curries	CCW	CRS	16	M	5 3/4"	2", 4"	WPS	SW	Curries	707S	CRS	18	1 3/4"	FG*	TYPE 9	HC	N	PRIME-GRAY
135	E-2	36"	80"	Single	503		RH	AQUATICS 141	TO	STORAGE 135		Curries	M	CRS	16	M	5 3/4"	2", 4"	WSC	SW	Curries	707S	CRS	18	1 3/4"	F		HC	N	PRIME-GRAY
136	E-2	36"	80"	Single	201		RH	STORAGE 135	TO	SAFE ROOM 136		Curries	M	CRS	16	M	5 3/4"	2", 4"	WSC	SW	Curries	707S	CRS	18	1 3/4"	F		HC	N	PRIME-GRAY

Opening Number(s)	Elevation	Nominal Width	Nominal Height	Type	Hardware Group	Remarks	Hand	Location 1	To/ From	Location 2	Label	Frame Catalog	Frame Series	Frame Mat'l	Frame Gauge	Frame Profile	Jamb Depth	Facing (Jamb, Hd)	Anchor Type	Frame Construction	Door Catalog	Door Series	Door Mat'l	Door Gauge	Door Thickness	Door Type	Door Lite Kit	Door Core	Door Seam	Door Finish	
137	E-2	36"	80"	Single	503A		RH	AQUATICS 141	TO	CONFERENCE 137		Curries	M	CRS	16	M	5 3/4"	2", 4"	WSC	SW	Curries	707S	CRS	18	1 3/4"	FG*	TYPE 9	HC	N	PRIME-GRAY	
138A	 2-RH	36"	80"	Single	501A		RH	CORRIDOR 138A	TO	PMD 138		Curries	CCW	CRS	16	M	5 3/4"	2", 4"	WPS	SW	Curries	707S	CRS	18	1 3/4"	FG*	TYPE 9	HC	N	PRIME-GRAY	
138AA		36", 36"	84"	Pair	714A.1	ALUM STOREFRONT BY OTHERS	RHRA	EXTERIOR	FROM	CORRIDOR 138A				ALUMI	16		2", 4"						ALUMI								
138B	 2-LH	36"	80"	Single	501A		LH	CORRIDOR 138A	TO	PMD 138		Curries	CCW	CRS	16	M	5 3/4"	2", 4"	WPS	SW	Curries	707S	CRS	18	1 3/4"	FG*	TYPE 9	HC	N	PRIME-GRAY	
139	E-2	36"	80"	Single	103A		RH	AQUATICS 141	TO	OFFICE 139		Curries	M	CRS	16	M	5 3/4"	2", 4"	WSC	SW	Curries	707S	CRS	18	1 3/4"	FG*	TYPE 9	HC	N	PRIME-GRAY	
140	E-1	36"	80"	Single	103A		LH	AQUATICS 141	TO	OFFICE 140		Curries	M	CRS	16	M	5 3/4"	2", 4"	WSC	SW	Curries	707S	CRS	18	1 3/4"	FG*	TYPE 9	HC	N	PRIME-GRAY	
141	 2-LH	36"	80"	Single	507A		LH	CORRIDOR 138A	TO	AQUATICS 141		Curries	CCW	CRS	16	M	5 3/4"	2", 4"	WPS	SW	Curries	707S	CRS	18	1 3/4"	FG*	TYPE 9	HC	N	PRIME-GRAY	
142	E-3	44"	80"	Single	731R.2		LHR	CORRIDOR 138A	FROM	STAIR 142		Curries	M	CRS	16	M	5 3/4"	2", 4"	WPS	SW	Curries	707S	CRS	18	1 3/4"	F		HC	N	PRIME-GRAY	
143	E-2	36"	80"	Single	801		RH	CORRIDOR 148A	TO	WOMENS 143		Curries	M	CRS	16	M	5 3/4"	2", 4"	WPS	SW	Curries	707S	CRS	18	1 3/4"	F		HC	N	PRIME-GRAY	
144A	 2-LH	36"	80"	Single	801A		LH	CORRIDOR 148A	TO	BREAKROOM 144		Curries	CCW	CRS	16	M	5 3/4"	2", 4"	WPS	SW	Curries	707S	CRS	18	1 3/4"	FG*	TYPE 9	HC	N	PRIME-GRAY	
144B	 2-RH	36"	80"	Single	801A		RH	CORRIDOR 148A	TO	BREAKROOM 144		Curries	CCW	CRS	16	M	5 3/4"	2", 4"	WPS	SW	Curries	707S	CRS	18	1 3/4"	FG*	TYPE 9	HC	N	PRIME-GRAY	
144C		36"	80"	Single	205.1	AL STOREFRONT BY OTHERS	RHR																								



Opening Number(s)	Elevation	Nominal Width	Nominal Height	Type	Hardware Group	Remarks	Hand	Location 1	To/ From	Location 2	Label	Frame Catalog	Frame Series	Frame Mat'l	Frame Gauge	Frame Profile	Jamb Depth	Facing (Jamb, Hd)	Anchor Type	Frame Construction	Door Catalog	Door Series	Door Mat'l	Door Gauge	Door Thickness	Door Type	Door Lite Kit	Door Core	Door Seam	Door Finish
144D		36"	80"	Single	205.1	AL STOREFRONT BY OTHERS	LHR																							
145	E-1	36"	80"	Single	801		LH	CORRIDOR 148A	TO	MENS 145		Curries	M	CRS	16	M	5 3/4"	2", 4"	WPS	SW	Curries	707S	CRS	18	1 3/4"	F		HC	N	PRIME-GRAY
146	 4-RH	36"	80"	Single	503A	TO BE MODIFIED FOR ELECT HDW IN FIELD	RH	CORRIDOR 148A	TO	FITNESS 146		Curries	CCW	CRS	16	M	5 3/4"	2", 4"	WSC	SW	Curries	707S	CRS	18	1 3/4"	FG*	TYPE 9	HC	N	PRIME-GRAY
147	 4-LH	36"	80"	Single	503A	TO BE MODIFIED FOR ELECT HDW IN FIELD	LH	CORRIDOR 148A	TO	CONFERENCE 147		Curries	CCW	CRS	16	M	5 3/4"	2", 4"	WSC	SW	Curries	707S	CRS	18	1 3/4"	FG*	TYPE 9	HC	N	PRIME-GRAY
148A	E-5	36", 36"	80"	Pair	714A	TO BE MODIFIED FOR ELECT HDW IN FIELD Storefront door	RHRA	EXTERIOR	FROM	RECEPTION 148		Curries	M	A60	16	M	5 3/4"	2", 4"	WPS	FW	Curries	747S	A60	14	1 3/4"	FG*	TYPE 9	SS-22	N	PRIME-GRAY
148B	 5-RHRA/LHRA	36", 36"	80"	Pair	700AC		LHRA	CORRIDOR 148A	FROM	TRAINING 150		Curries	CCW	CRS	16	M	5 3/4"	2", 4"	WSC	SW	Curries	707S	CRS	18	1 3/4"	FG*	TYPE 9	HC	N	PRIME-GRAY
148C	E-5	30", 30"	80"	Pair	500A	TO BE MODIFIED FOR ELECT HDW IN FIELD	RHRA	CORRIDOR 148A	FROM	UNMAKRED CORRIDOR		Curries	M	CRS	16	M	5 3/4"	2", 4"	WSC	SW	Curries	707S	CRS	18	1 3/4"	FG*	TYPE 9	HC	N	PRIME-GRAY
149B	E-5	42", 42"	80"	Pair	200CW	45 min rating	RHRA	TRAINING 150	FROM	STORAGE 149	WH-C	Curries	M	CRS	16	M	5 3/4"	2", 4"	WSC	SW	Curries	707S	CRS	18	1 3/4"	F		HC	N	PRIME-GRAY
150A	E-4	36"	80"	Single	725A		RHR	EXTERIOR	FROM	TRAINING 150		Curries	M	A60	16	M	5 3/4"	2", 4"	WPS	FW	Curries	747S	A60	14	1 3/4"	FG*	TYPE 9	SS-22	N	PRIME-GRAY
150B	E-3	36"	80"	Single	725A		LHR	EXTERIOR	FROM	TRAINING 150		Curries	M	A60	16	M	5 3/4"	2", 4"	WPS	FW	Curries	747S	A60	14	1 3/4"	FG*	TYPE 9	SS-22	N	PRIME-GRAY
151	E-2	36"	80"	Single	201		RH	PMD 138	TO	STORAGE 151		Curries	M	CRS	16	M	5 3/4"	2", 4"	WSC	SW	Curries	707S	CRS	18	1 3/4"	FG*	TYPE 9	HC	N	PRIME-GRAY
152	E-4	42"	80"	Single	201.1		RHR	OFFICE 124	FROM	CLOSET 152		Curries	M	CRS	16	M	5 3/4"	2", 4"	WSC	SW	Curries	707S	CRS	18	1 3/4"	F		HC	N	PRIME-GRAY
201	 8-RH	36"	80"	Single	103A		RH	ENVIRO SAFETY 205	TO	OFFICE 201		Curries	CCW	CRS	16	M	5 3/4"	2", 4"	WSC	SW	Curries	707S	CRS	18	1 3/4"	FG*	TYPE 9	HC	N	PRIME-GRAY

Opening Number(s)	Elevation	Nominal Width	Nominal Height	Type	Hardware Group	Remarks	Hand	Location 1	To/ From	Location 2	Label	Frame Catalog	Frame Series	Frame Mat'l	Frame Gauge	Frame Profile	Jamb Depth	Facing (Jamb, Hd)	Anchor Type	Frame Construction	Door Catalog	Door Series	Door Mat'l	Door Gauge	Door Thickness	Door Type	Lite Kit	Door Core	Door Seam	Door Finish
202	E-1	36"	80"	Single	103A		LH	SERVICES 206	TO	STORAGE 202		Curries	M	CRS	16	M	5 3/4"	2", 4"	WSC	SW	Curries	707S	CRS	18	1 3/4"	FG*	TYPE 9	HC	N	PRIME-GRAY
203	 2-RH	36"	80"	Single	103A		RH	ENVIRO SAFETY 205	TO	OFFICE 203		Curries	CCW	CRS	16	M	5 3/4"	2", 4"	WSC	SW	Curries	707S	CRS	18	1 3/4"	FG*	TYPE 9	HC	N	PRIME-GRAY
204	 2-LH	36"	80"	Single	503A		LH	SERVICES 206	TO	OFFICE 204		Curries	CCW	CRS	16	M	5 3/4"	2", 4"	WSC	SW	Curries	707S	CRS	18	1 3/4"	FG*	TYPE 9	HC	N	PRIME-GRAY
205	 2-LH	36"	80"	Single	507A		LH	CORRIDOR 227	TO	ENVIRO SAFETY 205		Curries	CCW	CRS	16	M	5 3/4"	2", 4"	WPS	SW	Curries	707S	CRS	18	1 3/4"	FG*	TYPE 9	HC	N	PRIME-GRAY
206	 2-LH	36"	80"	Single	507A		LH	CORRIDOR 227	TO	SERVICES 206		Curries	CCW	CRS	16	M	5 3/4"	2", 4"	WPS	SW	Curries	707S	CRS	18	1 3/4"	FG*	TYPE 9	HC	N	PRIME-GRAY
207	 2-RH	36"	80"	Single	103A		RH	SERVICES 206	TO	OFFICE 207		Curries	CCW	CRS	16	M	5 3/4"	2", 4"	WSC	SW	Curries	707S	CRS	18	1 3/4"	FG*	TYPE 9	HC	N	PRIME-GRAY
208	 2-LH	36"	80"	Single	103A		LH	CORRIDOR 227	TO	OFFICE 208		Curries	CCW	CRS	16	M	5 3/4"	2", 4"	WPS	SW	Curries	707S	CRS	18	1 3/4"	FG*	TYPE 9	HC	N	PRIME-GRAY
209	E-1	36"	80"	Single	503		LH	ENVIRO SAFETY 205	TO	STORAGE 209		Curries	M	CRS	16	M	5 3/4"	2", 4"	WSC	SW	Curries	707S	CRS	18	1 3/4"	FG*	TYPE 9	HC	N	PRIME-GRAY
210A	 2-LH	36"	80"	Single	507A		LH	CORRIDOR 227	TO	CONFERENCE 210		Curries	CCW	CRS	16	M	5 3/4"	2", 4"	WPS	SW	Curries	707S	CRS	18	1 3/4"	FG*	TYPE 9	HC	N	PRIME-GRAY
210B	E-4	36"	80"	Single	507A.1		RHR	CONFERENCE 210	FROM	OFFICE 208		Curries	M	CRS	16	M	5 3/4"	2", 4"	WSC	SW	Curries	707S	CRS	18	1 3/4"	FG*	TYPE 9	HC	N	PRIME-GRAY

Opening Number(s)	Elevation	Nominal Width	Nominal Height	Type	Hardware Group	Remarks	Hand	Location 1	To/ From	Location 2	Label	Frame Catalog	Frame Series	Frame Mat'l	Frame Gauge	Frame Profile	Jamb Depth	Facing (Jamb, Hd)	Anchor Type	Frame Construction	Door Catalog	Door Series	Door Mat'l	Door Gauge	Door Thickness	Door Type	Lite Kit	Door Core	Door Seam	Door Finish	
211	E-2	36"	80"	Single	201		RH	CORRIDOR 228	TO	MECH 211		Curries	M	CRS	16	M	5 3/4"	2", 4"	WPS	SW	Curries	707S	CRS	18	1 3/4"	F		HC	N	PRIME-GRAY	
212	E-2	36"	80"	Single	731R	45 min rating	RH	STAIR 212	FROM	CORRIDOR 228	WH-C	Curries	M	CRS	16	M	5 3/4"	2", 4"	WPS	SW	Curries	707S	CRS	18	1 3/4"	F		HC	N	PRIME-GRAY	
213	E-1	36"	80"	Single	503		LH	CORRIDOR 229	TO	WORKROOM 213		Curries	M	CRS	16	M	5 3/4"	2", 4"	WPS	SW	Curries	707S	CRS	18	1 3/4"	F		HC	N	PRIME-GRAY	
214	E-4	36"	80"	Single	201		RHR	WORKROOM 213	FROM	ELEC 214		Curries	M	CRS	16	M	5 3/4"	2", 4"	WSC	SW	Curries	707S	CRS	18	1 3/4"	F		HC	N	PRIME-GRAY	
215	E-1	36"	80"	Single	801		LH	CORRIDOR 229	TO	WOMENS 215		Curries	M	CRS	16	M	5 3/4"	2", 4"	WPS	SW	Curries	707S	CRS	18	1 3/4"	F		HC	N	PRIME-GRAY	
216	E-1	36"	80"	Single	201		LH	CORRIDOR 229	TO	JANITOR 216		Curries	M	CRS	16	M	5 3/4"	2", 4"	WPS	SW	Curries	707S	CRS	18	1 3/4"	F		HC	N	PRIME-GRAY	
217	E-2	36"	80"	Single	801		RH	CORRIDOR 229	TO	MENS 217		Curries	M	CRS	16	M	5 3/4"	2", 4"	WPS	SW	Curries	707S	CRS	18	1 3/4"	F		HC	N	PRIME-GRAY	
218	E-1	36"	80"	Single	103A		LH	SERVICES 223	TO	OFFICE 218		Curries	M	CRS	16	M	5 3/4"	2", 4"	WSC	SW	Curries	707S	CRS	18	1 3/4"	FG*	TYPE 9	HC	N	PRIME-GRAY	
219	E-1	36"	80"	Single	103A		LH	SERVICES 223	TO	OFFICE 219		Curries	M	CRS	16	M	5 3/4"	2", 4"	WSC	SW	Curries	707S	CRS	18	1 3/4"	FG*	TYPE 9	HC	N	PRIME-GRAY	
220	E-1	36"	80"	Single	103A		LH	SERVICES 223	TO	OFFICE 220		Curries	M	CRS	16	M	5 3/4"	2", 4"	WSC	SW	Curries	707S	CRS	18	1 3/4"	FG*	TYPE 9	HC	N	PRIME-GRAY	
221	E-1	36"	80"	Single	103A		LH	SERVICES 223	TO	OFFICE 221		Curries	M	CRS	16	M	5 3/4"	2", 4"	WSC	SW	Curries	707S	CRS	18	1 3/4"	FG*	TYPE 9	HC	N	PRIME-GRAY	
222A	E-2	36"	80"	Single	501	45 min rating	RH	CORRIDOR 229	TO	STORAGE 222	WH-C	Curries	M	CRS	16	M	5 3/4"	2", 4"	WPS	SW	Curries	707S	CRS	18	1 3/4"	F		HC	N	PRIME-GRAY	
222B	E-1	36"	80"	Single	507	45 min rating	LH	CORRIDOR 229	TO	STORAGE 222	WH-C	Curries	M	CRS	16	M	5 3/4"	2", 4"	WPS	SW	Curries	707S	CRS	18	1 3/4"	F		HC	N	PRIME-GRAY	
223		36"	80"	Single	507A		RH	CORRIDOR 229	TO	SERVICES 223		Curries	CCW	CRS	16	M	5 3/4"	2", 4"	WPS	SW	Curries	707S	CRS	18	1 3/4"	FG*	TYPE 9	HC	N	PRIME-GRAY	
225	E-2	44"	80"	Single	731R.1	45 min rating	RH	STAIR 225	FROM	CORRIDOR 229	WH-C	Curries	M	CRS	16	M	5 3/4"	2", 4"	WPS	SW	Curries	707S	CRS	18	1 3/4"	F		HC	N	PRIME-GRAY	



2-RH

Opening Number(s)	Elevation	Nominal Width	Nominal Height	Type	Hardware Group	Remarks	Hand	Location 1	To/ From	Location 2	Label	Frame Catalog	Frame Series	Frame Mat'l	Frame Gauge	Frame Profile	Jamb Depth	Facing (Jamb, Hd)	Anchor Type	Frame Construction	Door Catalog	Door Series	Door Mat'l	Door Gauge	Door Thickness	Door Type	Lite Kit	Door Core	Door Seam	Door Finish
301A	 7-LH	36"	80"	Single	103A		LH					Curries	CCW	CRS	16	M	5 3/4"	2", 4"	WSC	SW	Curries	707S	CRS	18	1 3/4"	FG*	TYPE 9	HC	N	PRIME-GRAY
301B	E-3	36"	80"	Single	507.1		LHR					Curries	M	CRS	16	M	5 3/4"	2", 4"	WSC	SW	Curries	707S	CRS	18	1 3/4"	F		HC	N	PRIME-GRAY
302*ALT2*	E-3	36"	80"	Single	341		LHR					Curries	M	CRS	16	M	5 3/4"	2", 4"	WSC	SW	Curries	707S	CRS	18	1 3/4"	F		HC	N	PRIME-GRAY
303*ALT2*	E-4	36"	80"	Single	341		RHR					Curries	M	CRS	16	M	5 3/4"	2", 4"	WSC	SW	Curries	707S	CRS	18	1 3/4"	F		HC	N	PRIME-GRAY
301-BL	 301-BL6											Curries	CCW	CRS	16	M	5 3/4"	2", 4"	WSC	SW										

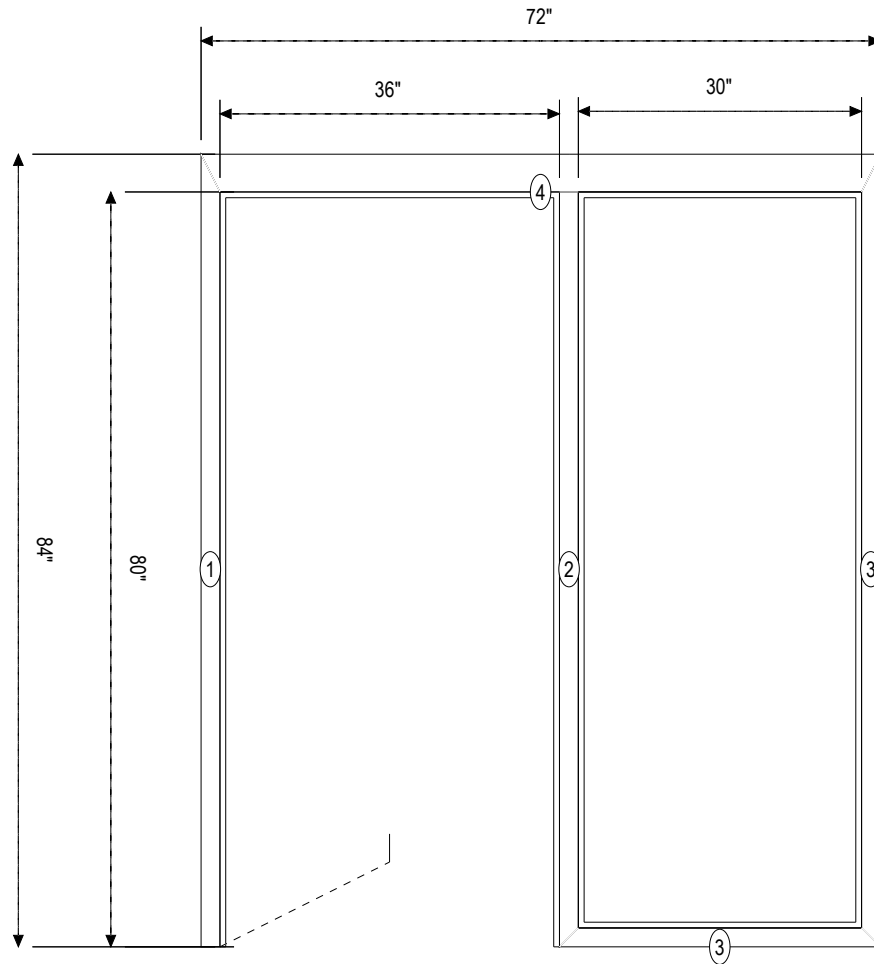

2-LH

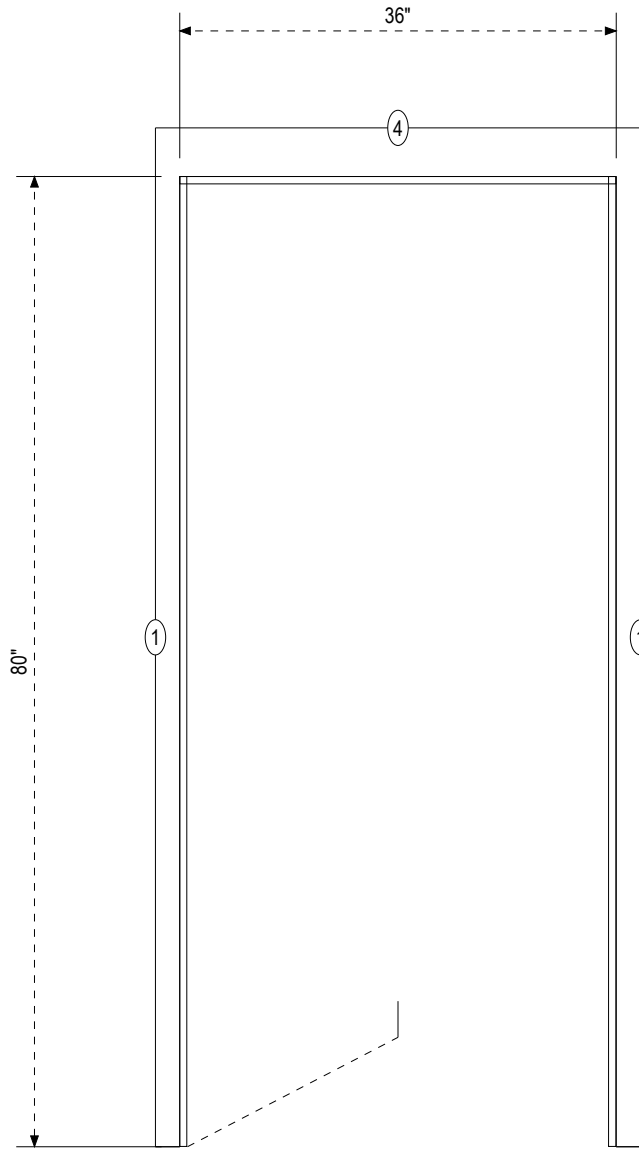

E-1

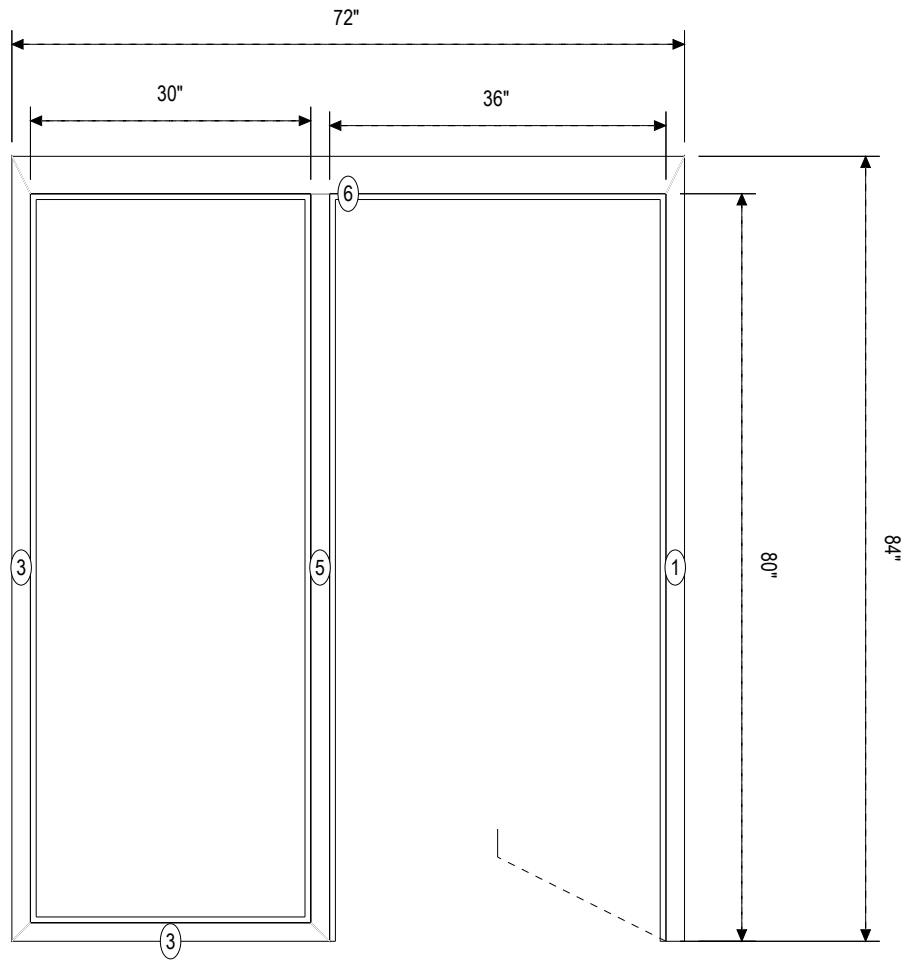

2-RH

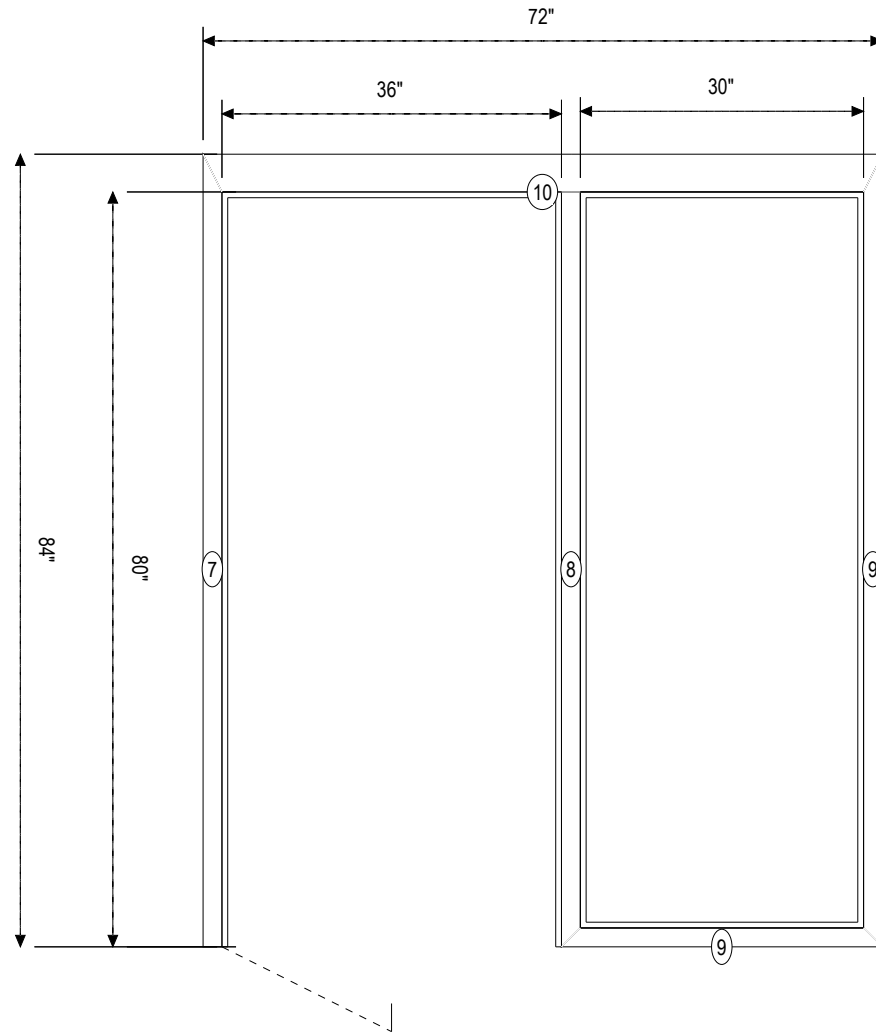

2-LHR-ADD

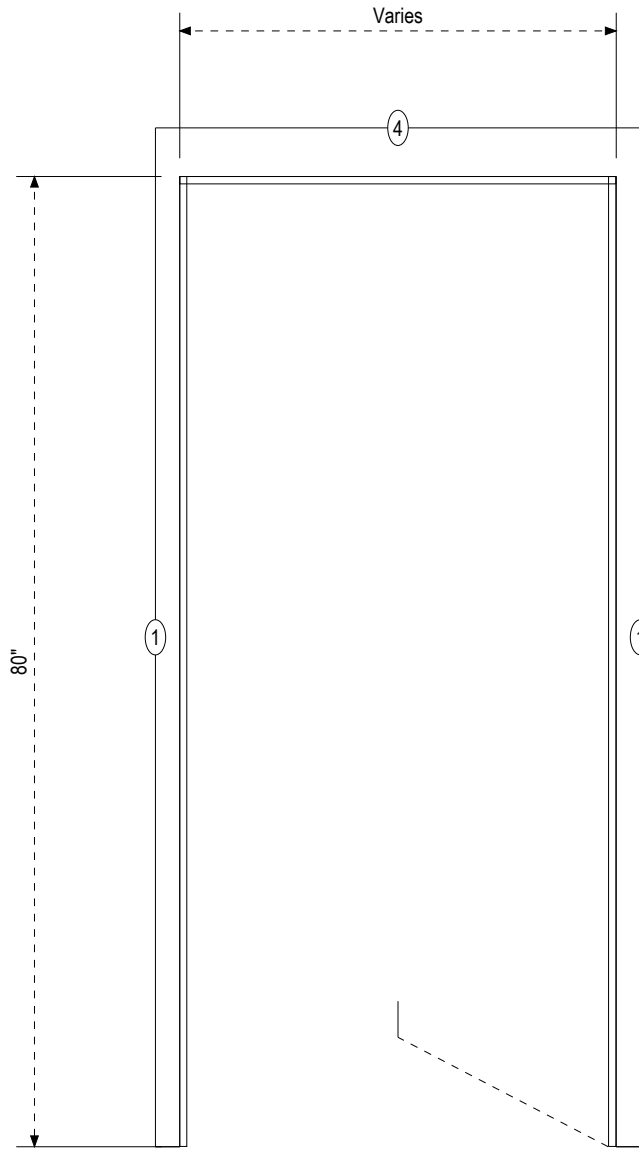

E-2

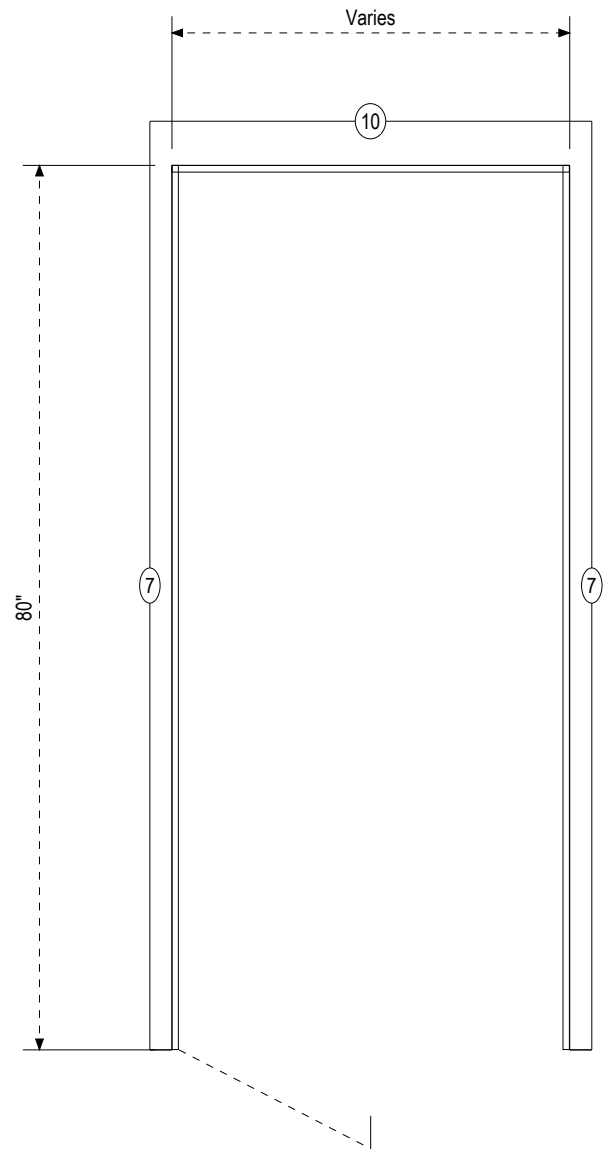

E-3

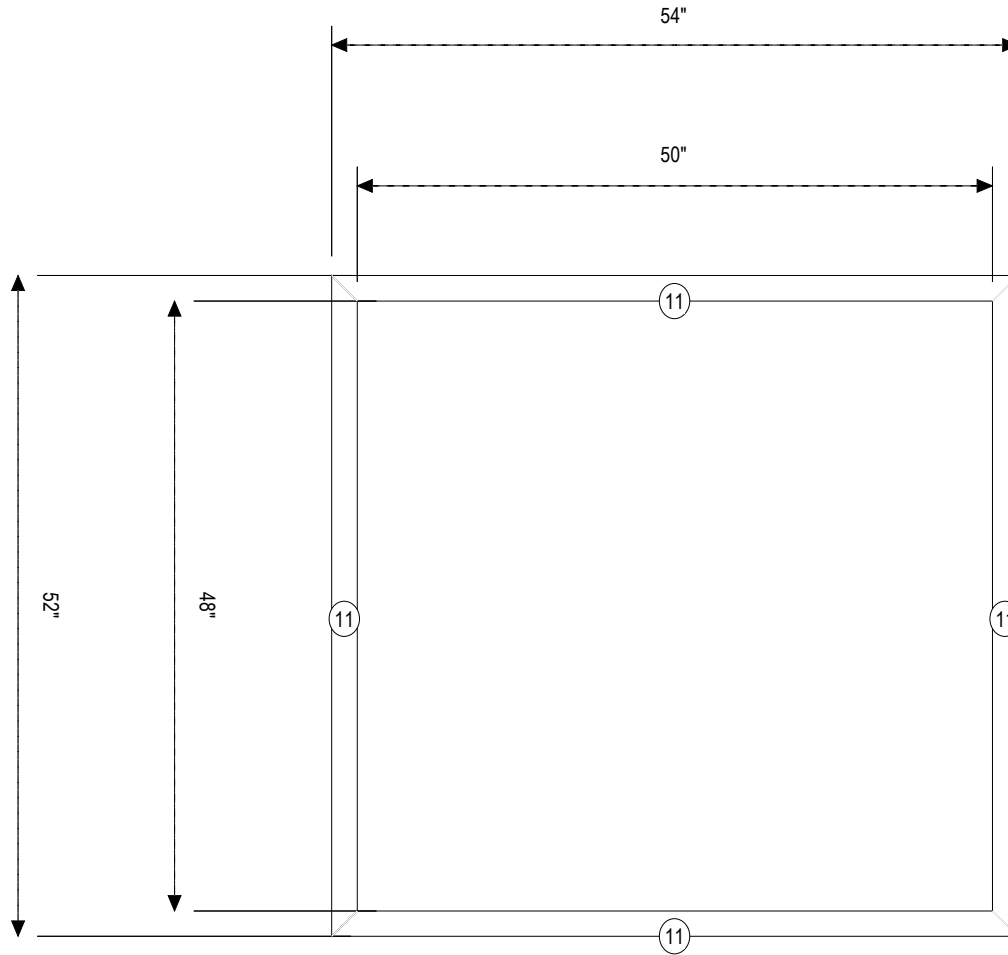

121--CASED-OPEN BL

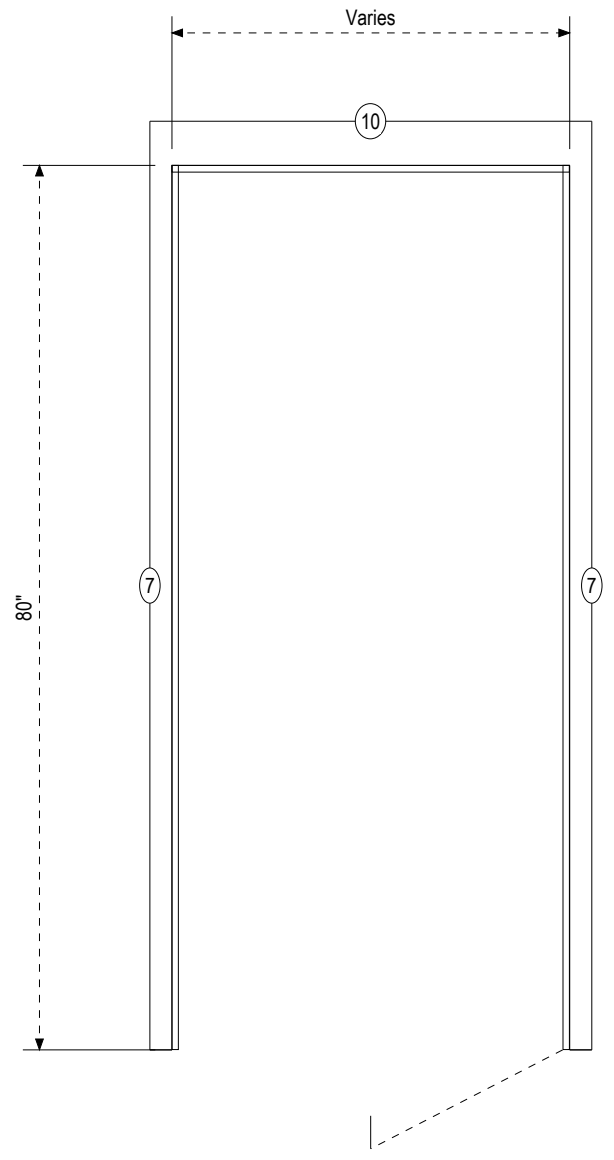

E-4

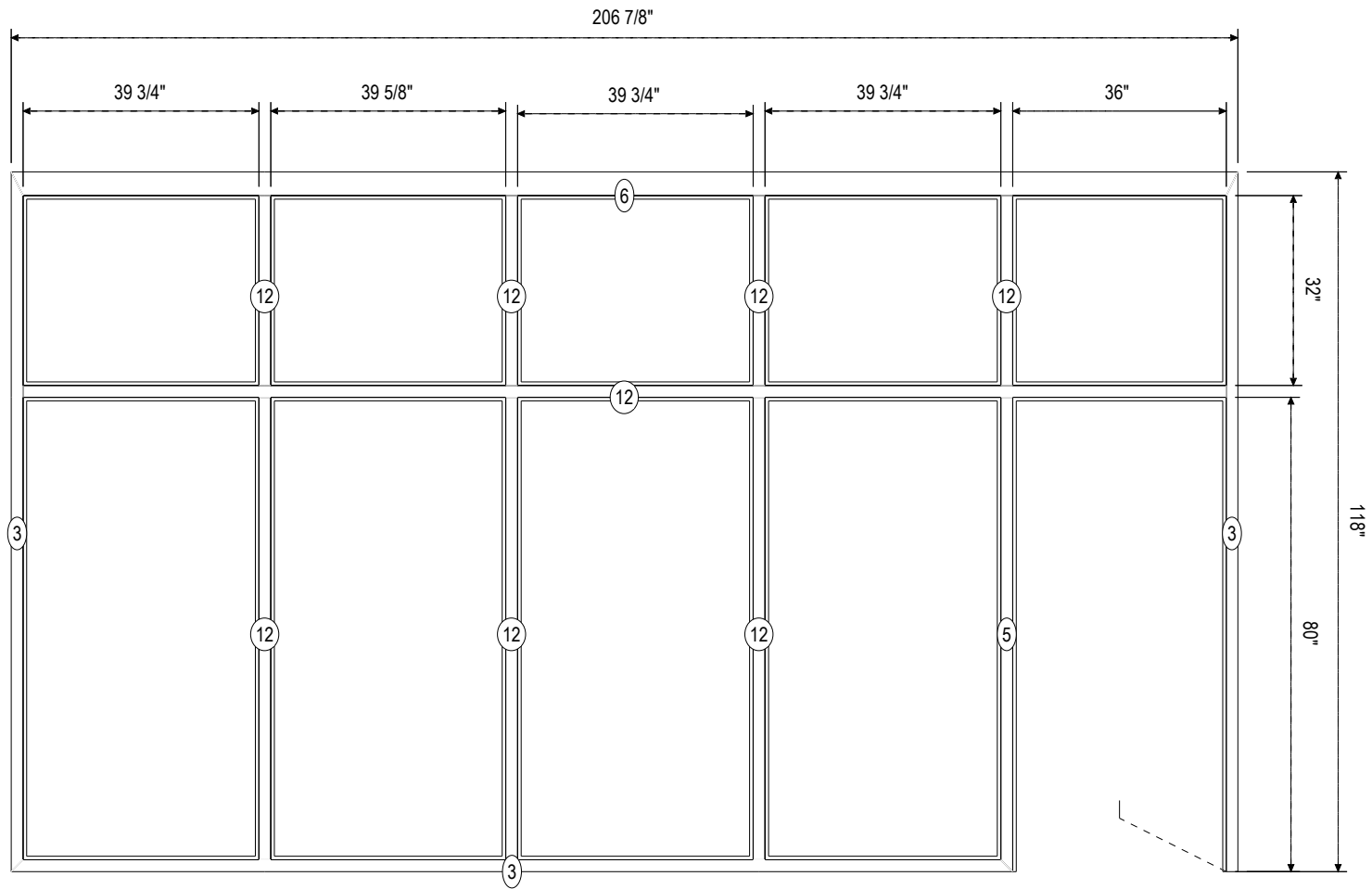

4-RH

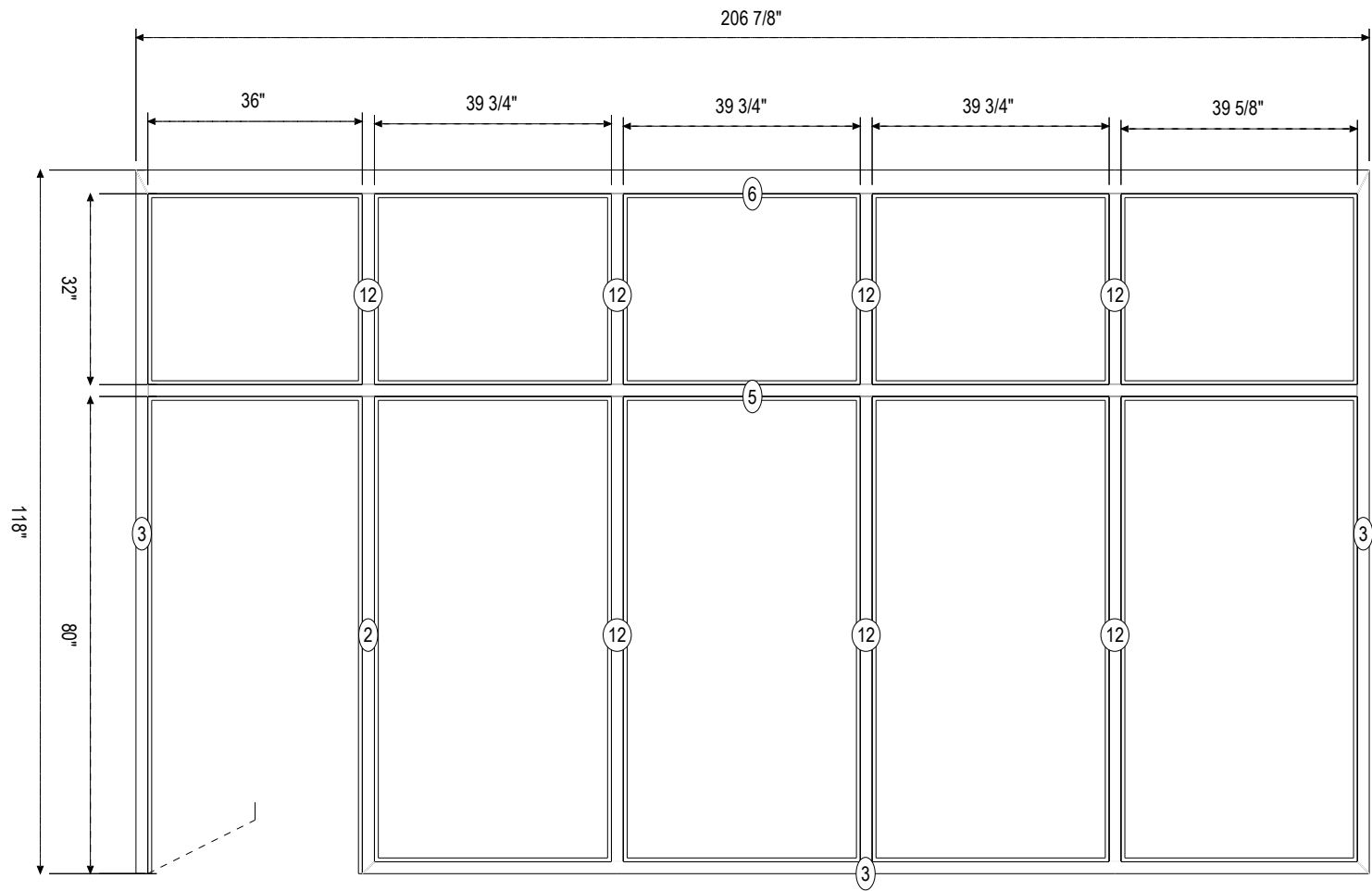

4-LH

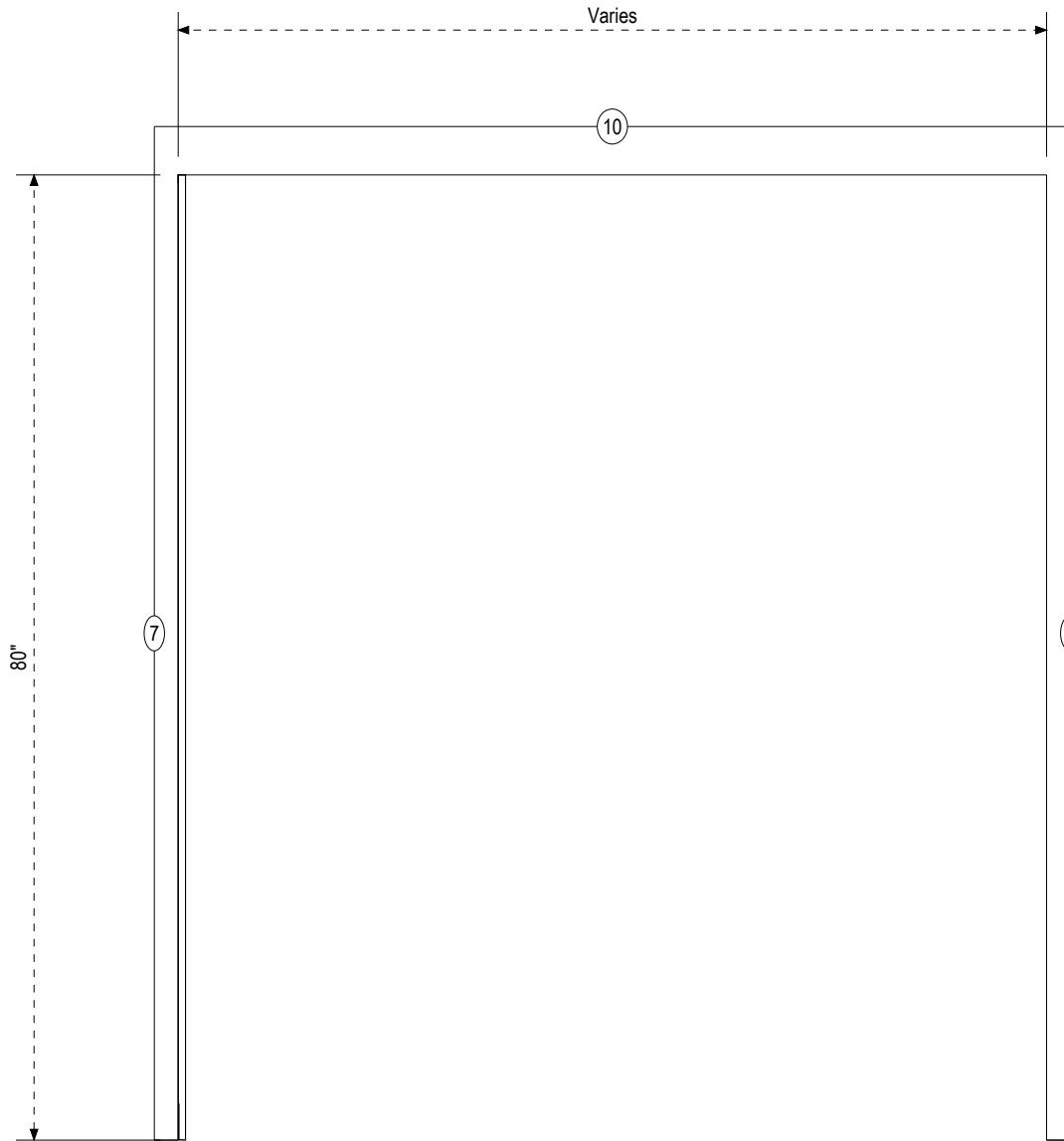

E-5

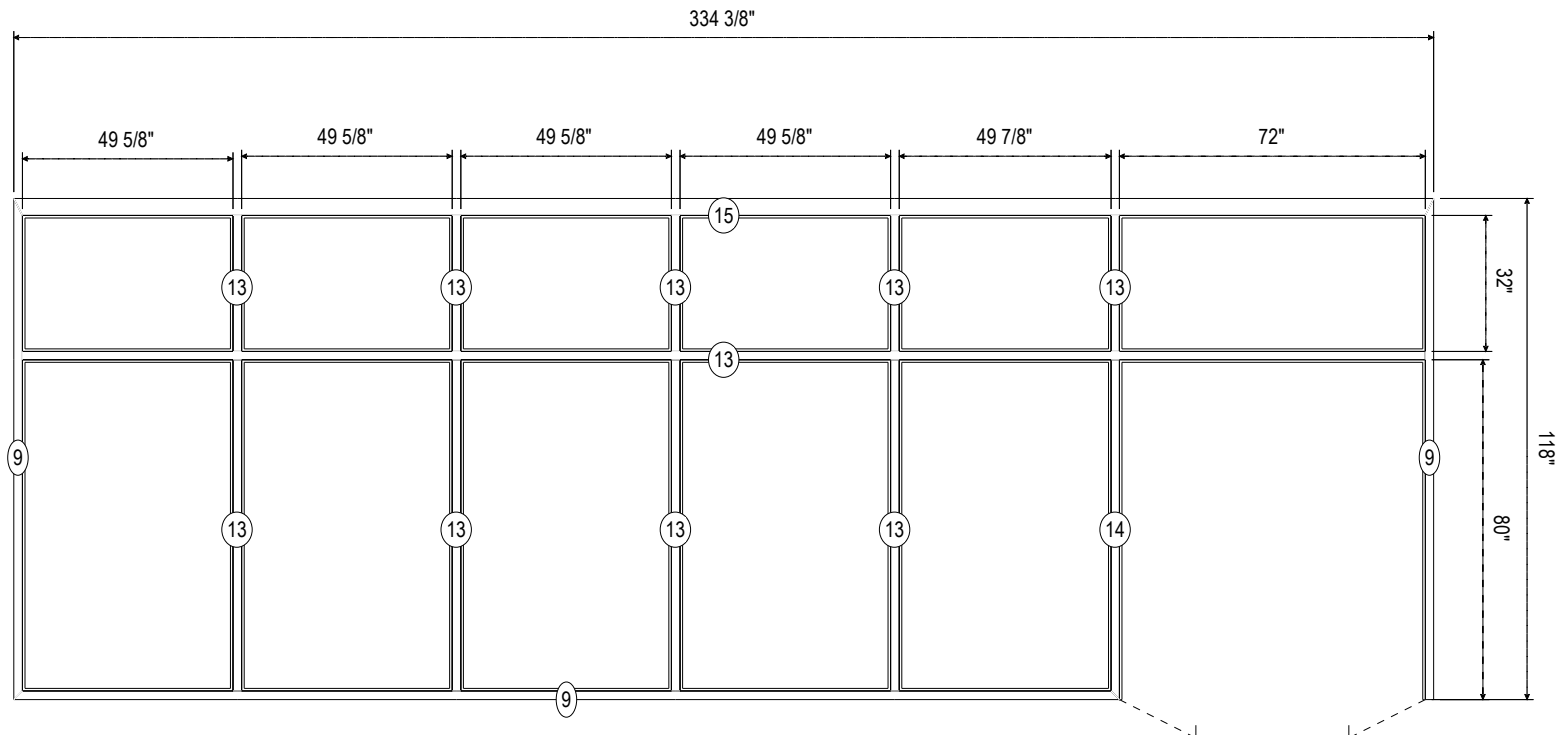

5-RHRA/LHRA

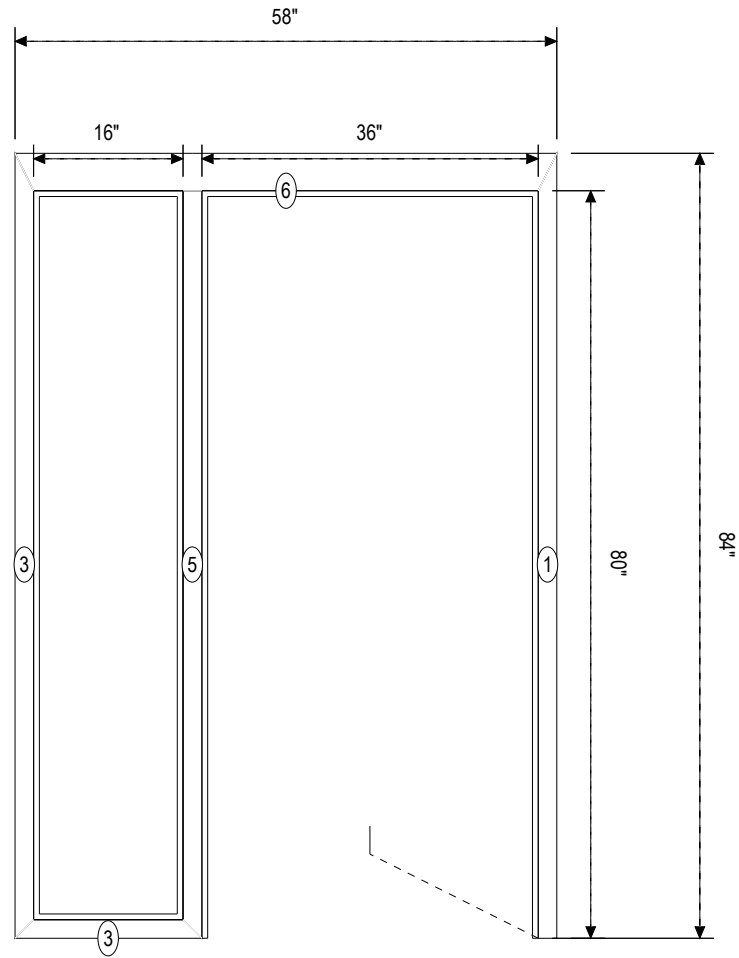

8-RH

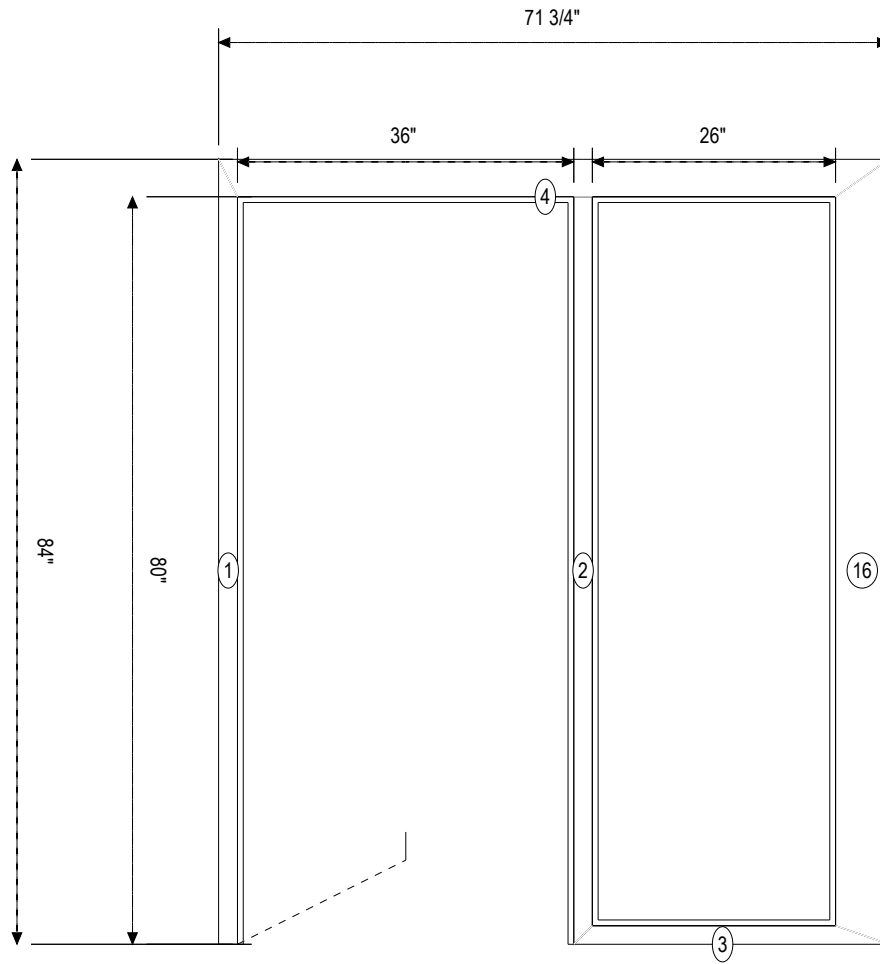

7-LH

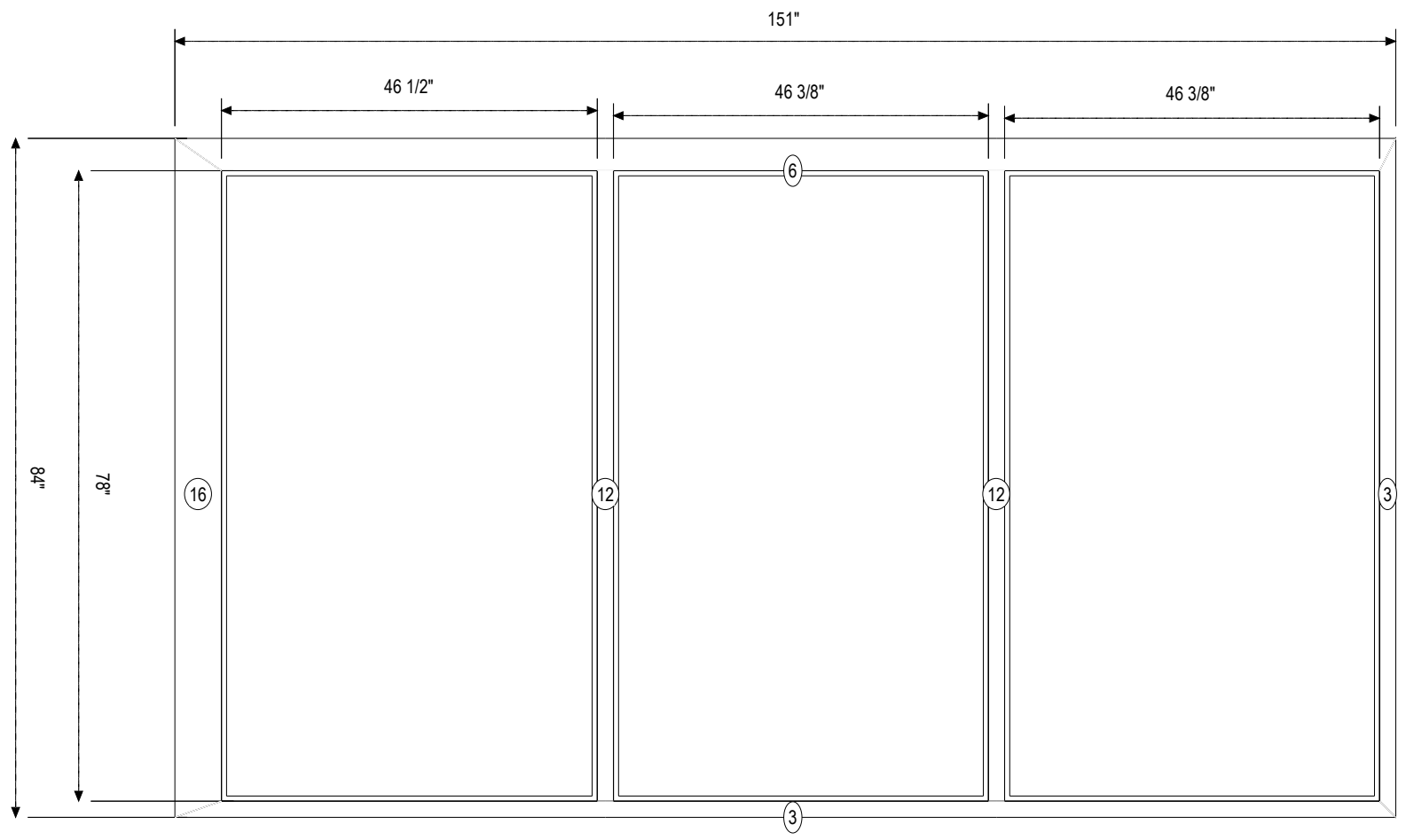

301-BL6

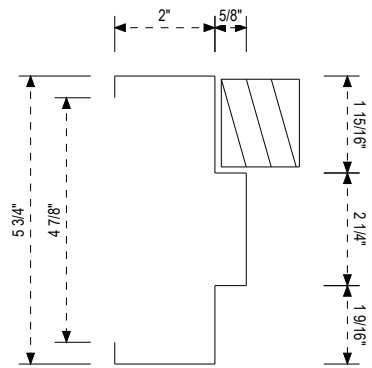

1

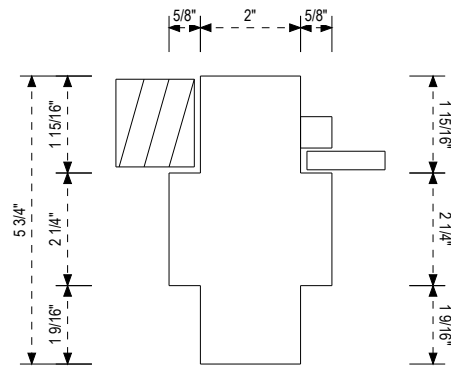

2

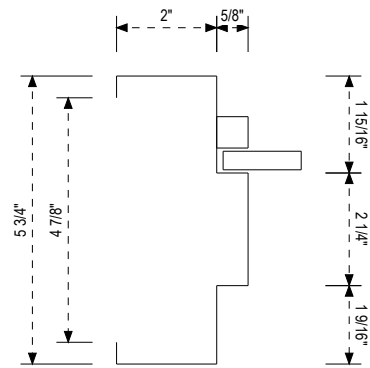

3

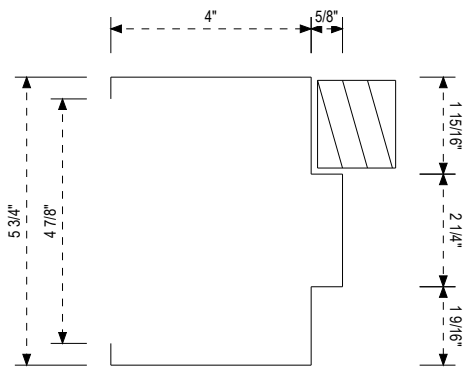

4

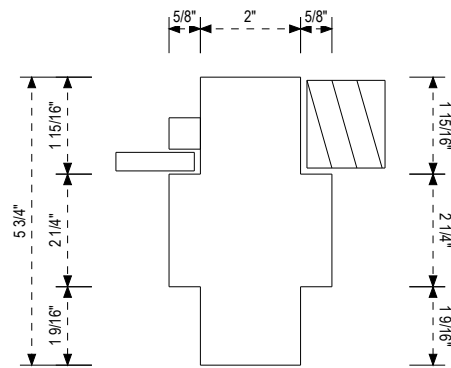

5

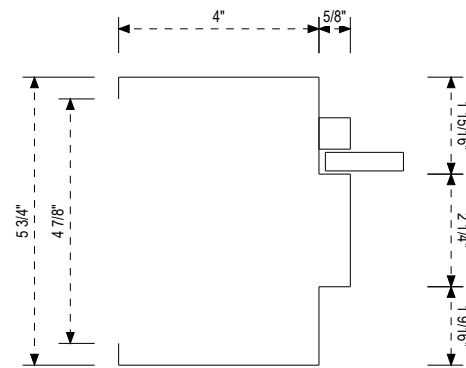

6

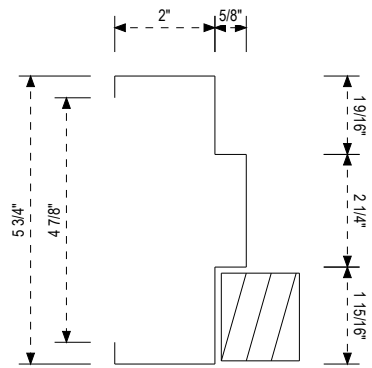

7

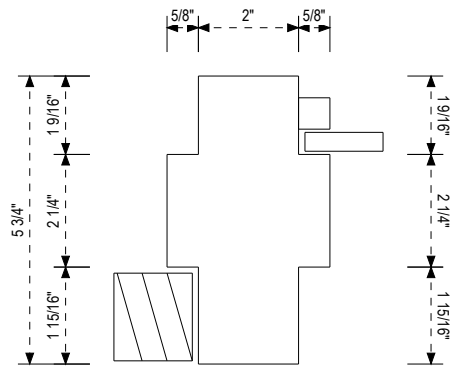

8

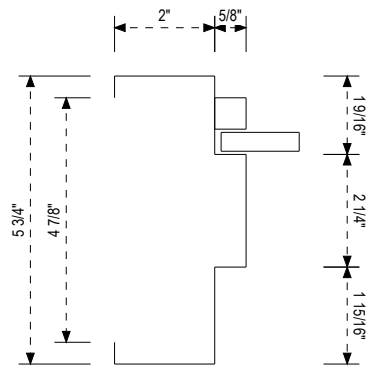

9

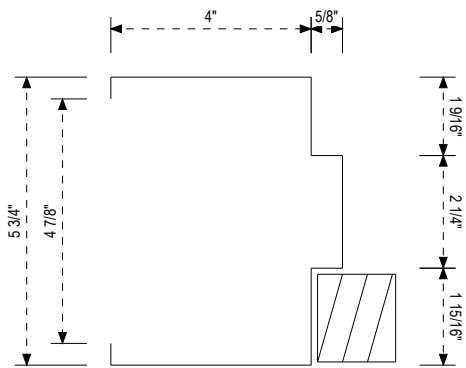

10

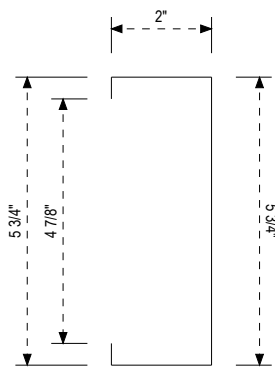

11

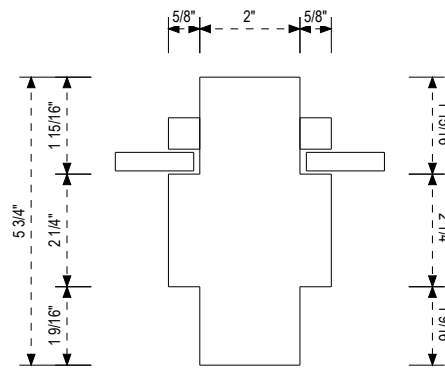

12

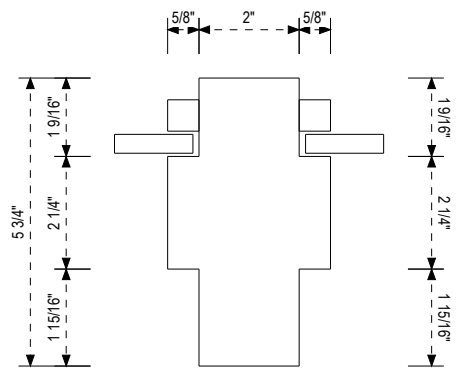

13

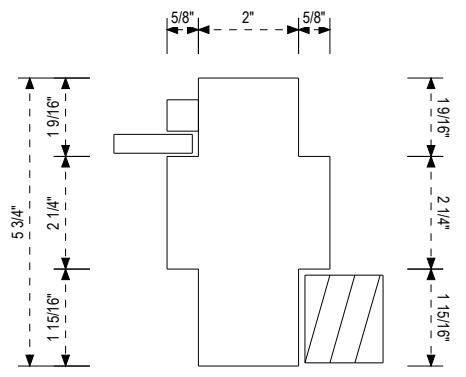

14

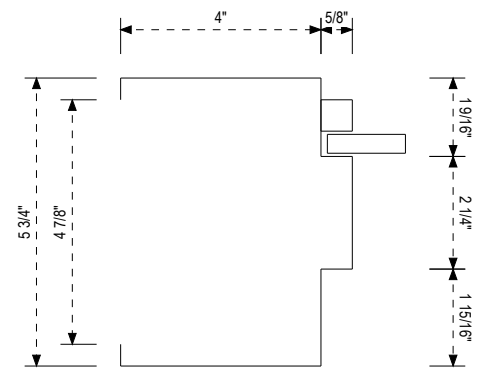

15

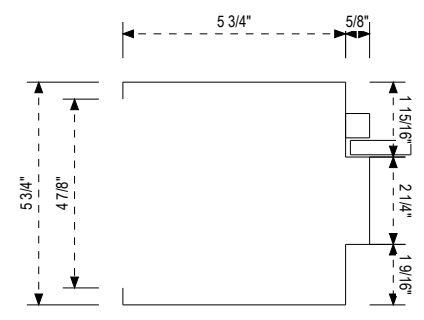

16

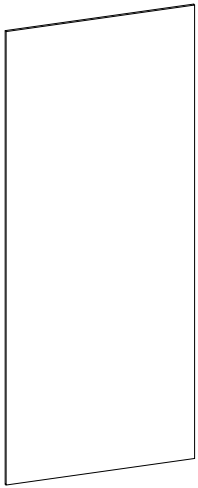

F

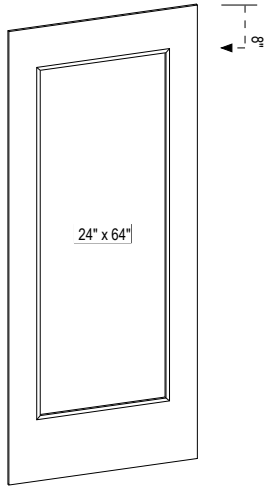

FG

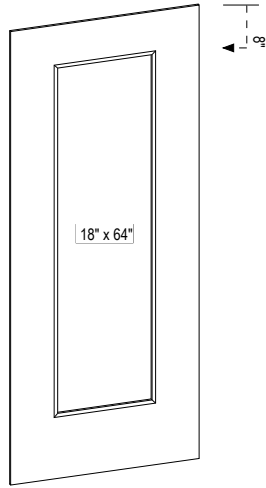

FG

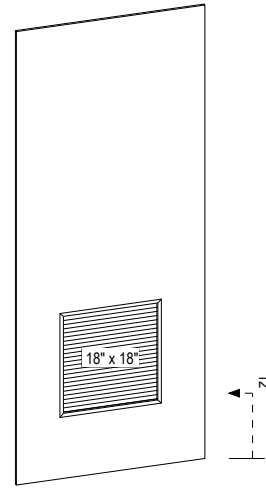

FL

Anchor Type

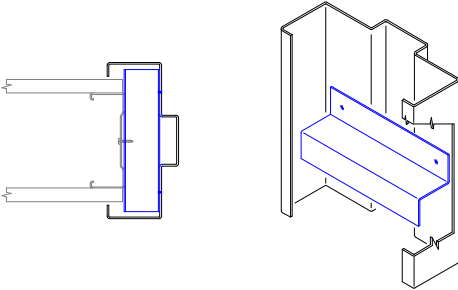

Welded Steel Stud Anchor (WSC)